

ULTRAFAST SWITCHING RECTIFIER

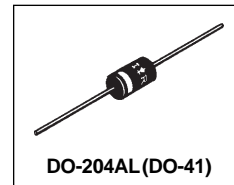

Major Ratings and Characteristics

Characteristics	10DF.	Units
$I_{F(AV)}$	1	A
V_{RRM} range	100 to 800	V
I_{FSM}	34	A
V_F @ 1 A, $T_J=25^\circ\text{C}$	1.2	V
t_{tr} @ $T_J=25^\circ\text{C}$	100	ns
T_J range	-65 to 150	$^\circ\text{C}$

Features

- Plastic package has Underwriters Laboratory Flammability Classification 94V-O utilizing Flame Retardant Epoxy Molding Compound
- Void-free Plastic in DO-41 package
- 1.0 ampere operation @ $T_A = 55^\circ\text{C}$ with no thermal runaway
- Exceeds environmental standards of MIL-STD-19500/228
- Ultra Fast switching for high efficiency

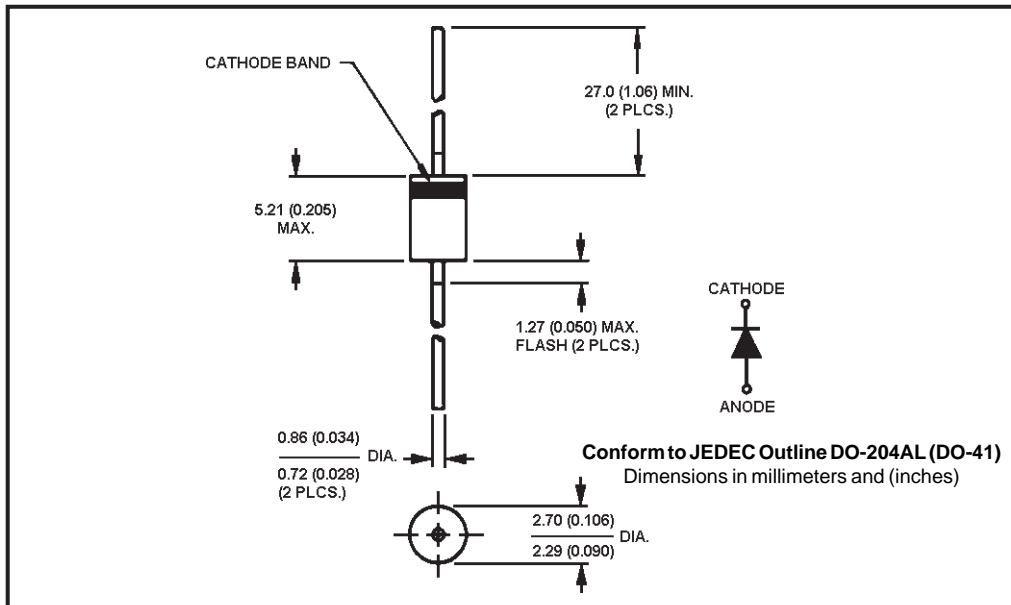

Voltage Ratings

Part Number	V_{RRM} , maximum peak reverse voltage V	V_{DC} , maximum blocking voltage V	I_{RRM} 100°C μA
10DF1	100	100	500
10DF2	200	200	
10DF4	400	400	
10DF6	600	600	
10DF8	800	800	

Maximum Ratings and Electrical Characteristics

Parameters	10DF.	Units	Conditions
$I_{F(AV)}$ Maximum Average Forward Current	1	A	@ $T_A = 55^\circ\text{C}$, 3/8" lead length, 60Hz resistive or inductive load
I_{FSM} Peak Forward Surge Current	34	A	8.3ms single half sine waves superimposed on rated load (JEDEC Method)
V_{FM} Max. Instantaneous Forward Voltage	1.2	V	@ 1A
I_{RM} Maximum DC Reverse Current at Rated DC Blocking Voltage	10	μA	$T_J = 25^\circ\text{C}$
	500		$T_J = 100^\circ\text{C}$
t_{rr} Reverse Recovery Time	100	ns	$I_F = 0.5\text{A}$, $I_R = 1.0\text{A}$, $I_{rr} = 0.25\text{A}$
C_J Typical Junction Capacitance	170	pf	@ 1MHz applied reverse voltage of $4.0V_{DC}$
R_{thJA} Max. Junction Thermal Resistance	115	$^\circ\text{C}/\text{W}$	lead length 0.375"(9.5mm) P.C.B. mounted
T_J Operating Temperature Range	-65 to 150	$^\circ\text{C}$	
T_{stg} Storage Temperature Range	-65 to 150	$^\circ\text{C}$	
wt Approximate Weight	0.3(0.013)	g(oz)	
Case Style	DO-204AL(DO-41)		JEDEC molded plastic

Ratings at 25°C ambient temperature unless otherwise specified.
Single phase, half wave, 60Hz, resistive or inductive load.

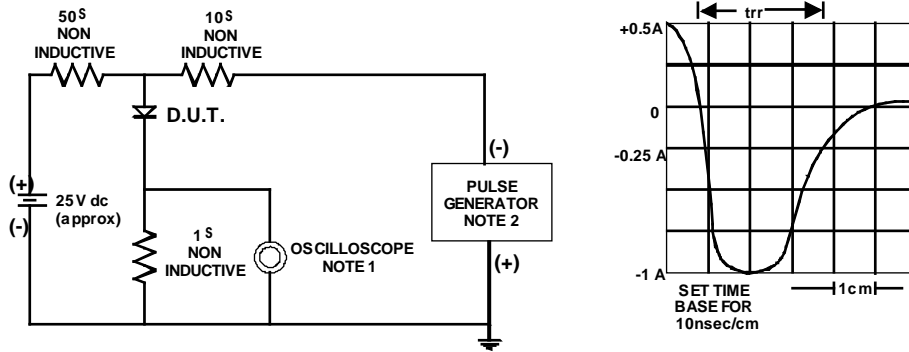

Fig. 1-Reverse Recovery Time Characteristic and Test Circuit Diagram

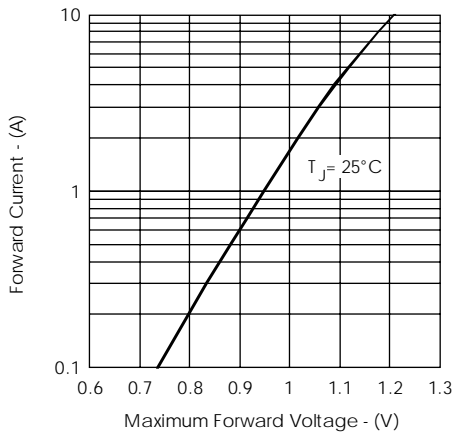

Fig. 2-Forward Characteristic

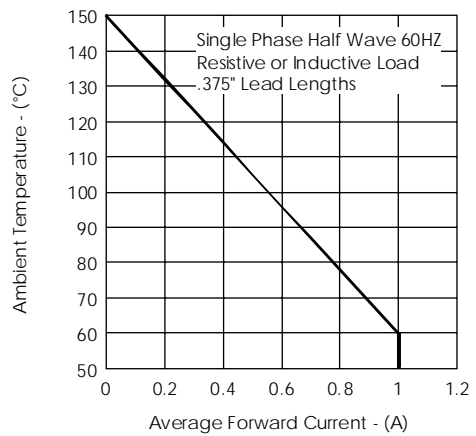

Fig. 6-Forward Current Derating Curve

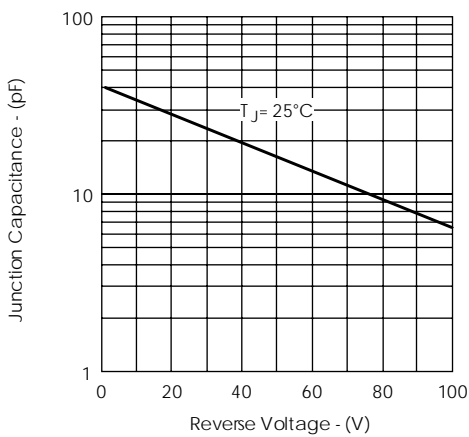

Fig. 3-Typical Junction Capacitance

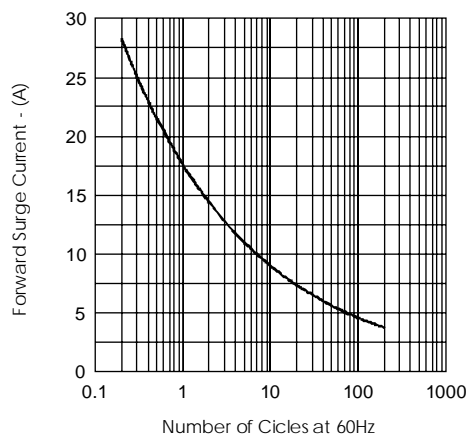
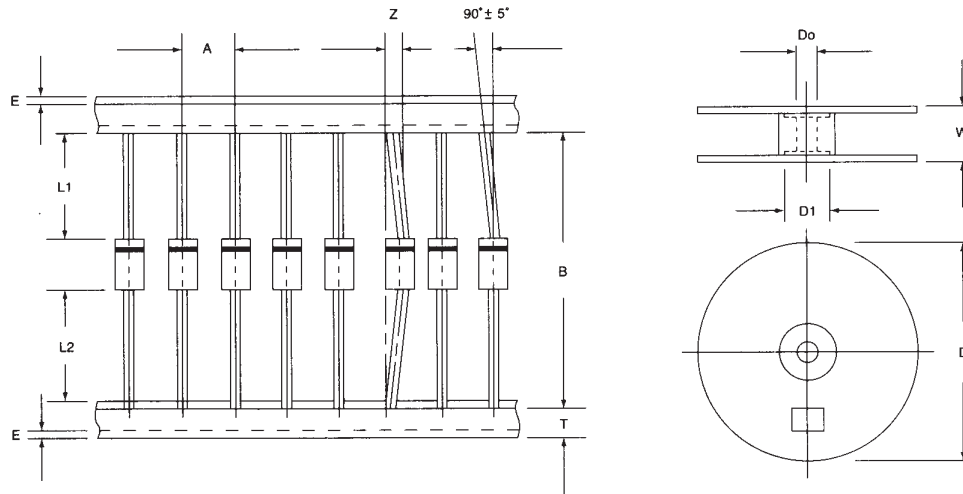

Fig. 4-Forward Surge Characteristic

TAPING SPECIFICATIONS FOR AXIAL LEAD

Axial lead devices are packed in accordance with EIA standard RS-296-E and specifications given below.

COMPONENT OUTLINE	COMPONENT PITCH A	INNER TAPE PITCH B	CUMULATIVE PITCH TOLERANCE
	DO-41	± 0.5mm	
	5.0mm	52.0mm	1.0mm/20pitch



ITEM	SYMBOL	SPECIFICATIONS (mm)	SPECIFICATIONS (inch)
Component alignment	Z	1.2max	0.048max
Tape width	T	6.0 ± 0.4	0.236 ± 0.016
Exposed adhesive	E	0.8max	0.032max
Body eccentricity	L1-L2	1.0max	0.040max
Reel outside diameter	D	330.0	13.0
Reel inner diameter	D ₁	85.7 ± 0.3	3.375 ± 0.012
Feed hole diameter	D ₀	16.6 ± 0.4	0.655 ± 0.016
Reel width	W	79.0 ± 1.0	3.110 ± 0.040

NOTES: 1. Each component lead shall be sandwiched between tapes for a minimum of 3.2mm (0.126")
 2. The reel width 'w' FOR 26mm Taping is 50.0 ± 1.0mm (1.97" ± 0.040")